

Features

- Durable, Corrosion Resistant Cast Aluminum Construction
- UL Type 1
- Multi-Position Guide Arm can be mounted in two different positions
- Positive Latch mechanism automatically maintains desired cord length
- Ratchet Lock can be disengaged in field for constant tension applications



Ordering Information

Description	UPC	Catalog Number
White Industrial Reel with Yellow Box, GFCI Module and (2) 20A Duplex Receptacle , UL Type 1, 35 Ft , #12/3 SJO, 20 A, 250 VAC	783585586342	HBLI35123GF220

Listings

cULus Listed

Specifications

Spool	Aluminum
Guide Frame	Thermoplastic
Cord	Copper
Internal Terminals	Copper Alloy
Ball Stopper	Thermoplastic
Fitting	Aluminum

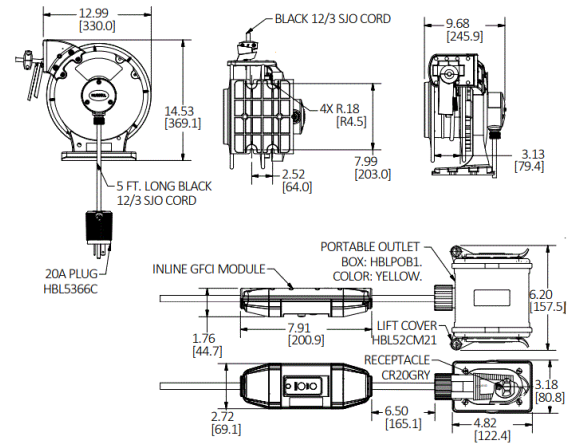

Related Products

Pivot Base	HBLI340PB
Mounting Bracket	HBLIMB
Ball Stop	HBLI12BS

Online Resources

- Customer Drawing
- Customer Sales Drawings
- eCatalog
- Installation Instructions
- Installation/Instruction Manual