

## Wire Management Products

### Cord and Cable Reels

## Industrial Power Cord Reels

# HUBBELL

### Features

- Durable, Corrosion Resistant Cast Aluminum Construction
- UL Type 1
- Multi-Position Guide Arm can be mounted in two different positions
- Positive Latch mechanism automatically maintains desired cord length
- Ratchet Lock can be disengaged in field for constant tension applications

### Ordering Information

**Description**  
Yellow Industrial Reel with  
Black Box and (2) 20A  
Duplex Receptacle, UL Type  
1, 35 Ft., #12/3 SJO, 20 A,  
250 VAC

**UPC Number** 783585585352  
**Catalog Number** HBLI35123R220M1Y

### Listings

cULus Listed

### Specifications

Spool	Aluminum
Guide Frame	Thermoplastic
Cord	Copper
Internal Terminals	Copper Alloy
Ball Stopper	Thermoplastic
Fitting	Aluminum

### Performance

**Amperage**  
20 A

**Max. Working Voltage**  
250V AC

**Moisture Resistance**  
Dry, Indoor, Non-Hazardous Locations - UL Type 1

**Number of Wires**  
3-Wire

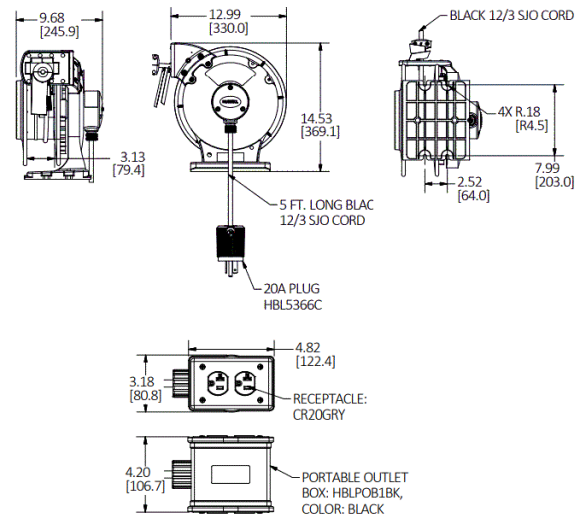

### Related Products

Pivot Base	HBLI340PB
Mounting Bracket	HBLIMB
Ball Stop	HBLI12BS

### Online Resources

Customer Drawing  
Customer Sales Drawings  
eCatalog  
Installation/Instruction Manual

Dimensions in Inches (mm)

Hubbell Wiring Device-Kellems • Hubbell Incorporated (Delaware) • 40 Waterview Drive • Shelton, CT 06484

Phone (800) 288-6000 • Fax (800) 255-1031 • Specifications subject to change without notice.

