

**Features**

- Durable, Corrosion Resistant Cast Aluminum Construction
- UL Type 1
- Multi-Position Guide Arm can be mounted in two different positions
- Positive Latch mechanism automatically maintains desired cord length
- Ratchet Lock can be disengaged in field for constant tension applications



**Ordering Information**

Description	UPC	Catalog Number
White Industrial Reel with Yellow Box, GFCI Module and (2) 15A Duplex Receptacle , UL Type 1, 35 Ft , #14/3 SJO, 15 A, 250 VAC	783585669427	HBLI35143GF215

**Listings**

cULus Listed

**Specifications**

Spool	Aluminum
Guide Frame	Thermoplastic
Cord	Copper
Internal Terminals	Copper Alloy
Ball Stopper	Thermoplastic
Fitting	Aluminum

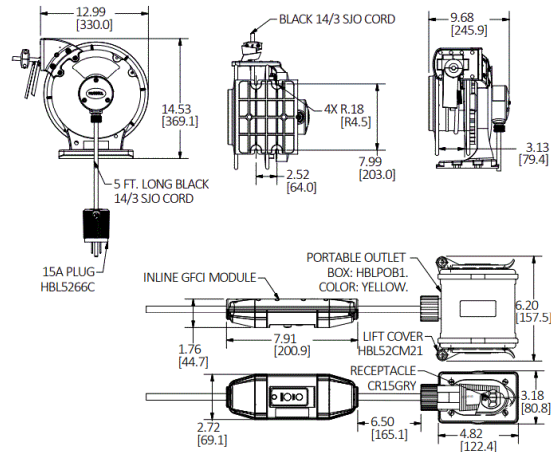

**Related Products**

Pivot Base	HBLI340PB
Mounting Bracket	HBLIMB
Ball Stop	HBLI16BS

**Online Resources**

- Customer Drawing
- Customer Sales Drawings
- eCatalog
- Installation Instructions
- Installation/Instruction Manual