

## Wire Management Products

### Cord and Cable Reels

### Industrial Power Cord Reels

# HUBBELL

#### Features

- Durable, Corrosion Resistant Cast Aluminum Construction
- UL Type 1
- Multi-Position Guide Arm can be mounted in two different positions
- Positive Latch mechanism automatically maintains desired cord length
- Ratchet Lock can be disengaged in field for constant tension applications

#### Ordering Information

Description	UPC	Catalog Number
Yellow Industrial Reel with Yellow Box and (1) 20A Duplex Receptacle, UL Type 1, 45 Ft, #12/3 SJO, 20 A, 250 VAC	783585585048	HBLI45123R20Y

#### Listings

cULus Listed

#### Specifications

Spool	Aluminum
Guide Frame	Thermoplastic
Cord	Copper
Internal Terminals	Copper Alloy
Ball Stopper	Thermoplastic
Fitting	Aluminum

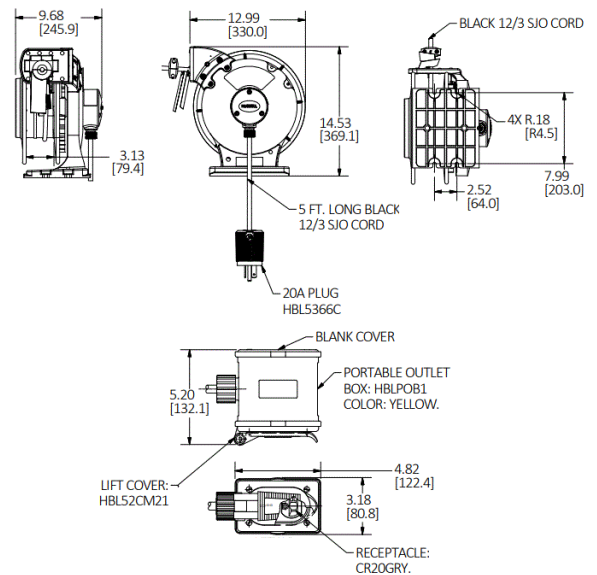

#### Related Products

Pivot Base	HBLI340PB
Mounting Bracket	HBLIMB
Ball Stop	HBLI12BS

#### Online Resources

Customer Drawing  
Customer Sales Drawings  
eCatalog  
Installation Instructions  
Installation/Instruction Manual

Dimensions in Inches (mm)

Hubbell Wiring Device-Kellems • Hubbell Incorporated (Delaware) • 40 Waterview Drive • Shelton, CT 06484

Phone (800) 288-6000 • Fax (800) 255-1031 • Specifications subject to change without notice.

