

## Features

- Durable, Corrosion Resistant Cast Aluminum Construction
- UL Type 1
- Multi-Position Guide Arm can be mounted in two different positions
- Positive Latch mechanism automatically maintains desired cord length
- Ratchet Lock can be disengaged in field for constant tension applications

## Ordering Information

Description	UPC	Catalog Number
White Industrial Reel with Yellow Box and (1) 20A Duplex Receptacle, UL Type 1, 45 Ft, #12/3 SJO, 20 A, 250 VAC	783585669205	HBLI45123R20

## Listings

cULus Listed

## Specifications

Spool	Aluminum
Guide Frame	Thermoplastic
Cord	Copper
Internal Terminals	Copper Alloy
Ball Stopper	Thermoplastic
Fitting	Aluminum

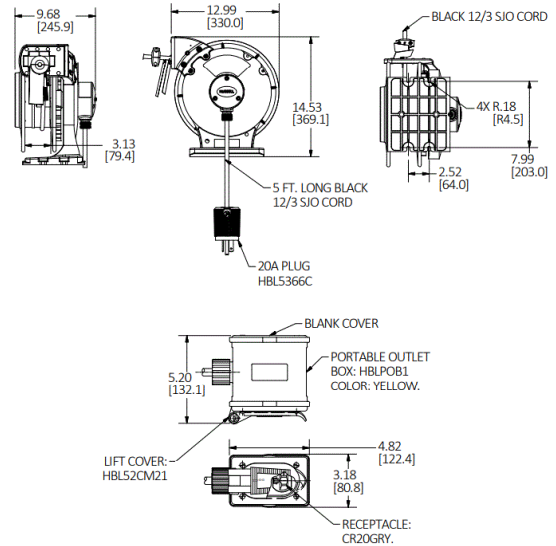

## Related Products

Pivot Base	HBLI340PB
Mounting Bracket	HBLIMB
Ball Stop	HBLI12BS

## Online Resources

Customer Drawing  
 Customer Sales Drawings  
 eCatalog  
 Installation Instructions  
 Installation/Instruction Manual