

# EFKVG-A4.400.2-1

## Actuator and Sensor Receptacle – Front Mount

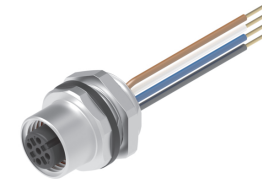
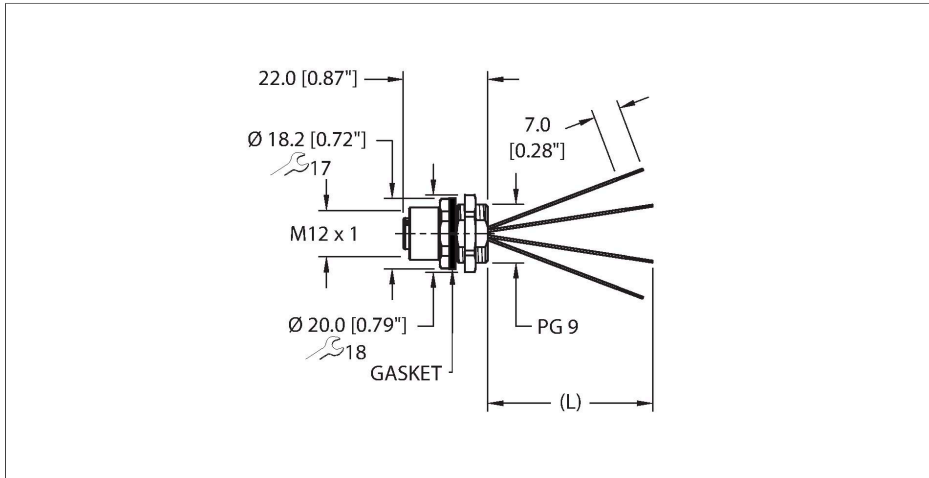

### Technical data

Type	EFKVG-A4.400.2-1
ID	100012568
Replaces	FKV 4.4-x
Connector A	Female, M12 × 1, A-code
Design specification	Acc. to IEC 61076-2-101
Number of contacts	4
Contacts	Bronze, CuSn, Gold-plated
Contact carriers	Plastic, TPU, Black
Connector seal	O-ring, FKM/FPM
Housing material/finish	Stainless Steel, Passivated
Tightening torque (range)	0.4 ... 1.8 Nm (note max. torque of mating connector!)
Mounting orientation	Front mount
Panel seal	Gasket, NBR
Mounting thread	PG9
Locknut	Stainless Steel, CuZn, Passivated
Receptacle mounting torque	2.5...6.8 Nm
Mechanical life	> 100 Mating cycles
Pollution degree	3
Protection class (When coupled)	IP67, IP68, IP69, IP69K NEMA: 1, 3, 4, 4X, 6P, 12
<b>Conductor data</b>	
Total number of conductors	4

### Features



- M12, Female, Receptacle, Front mount, 4-pin
- Mounting thread: PG9

### Contact assignment

Connector A

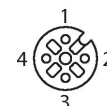

### Circuit Diagram



## Technical data

Length (L)	1 m, (+50mm or 4% of length/-0.0, Whichever is greater)
Conductor material	TC (tinned copper)
Conductor insulation material	PVC
Conductor size	22 AWG [Similar to 0.34 mm <sup>2</sup> ]
Conductor colors	BN, WH, BU, BK
<b>Electrical properties at +20 °C</b>	
Rated voltage	250 V <sub>AC</sub> /300 V <sub>DC</sub>
Current	4 A
<b>Mechanical and chemical properties</b>	
Ambient temperature range (static)	-40 °C...+105 °C
Approvals	UL 2238 CSA C22.2 No. 182.3 CE UKCA RoHS
<b>Note</b>	
- We reserve the right to make technical alterations without prior notice.	

### Mounting hole - Through

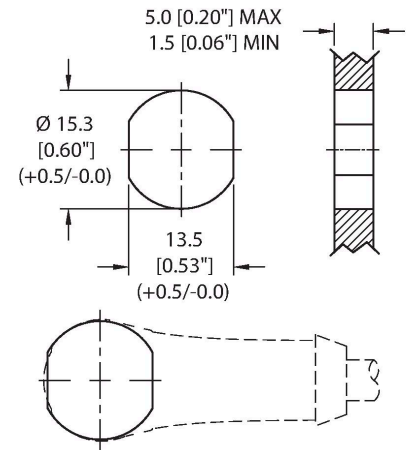

### Mounting hole - Threaded

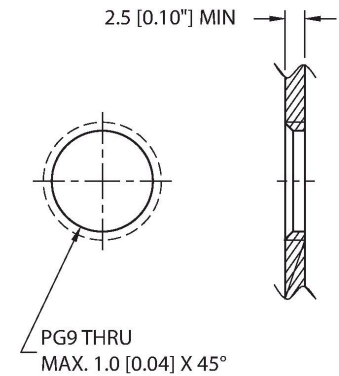

### Front panel mounting

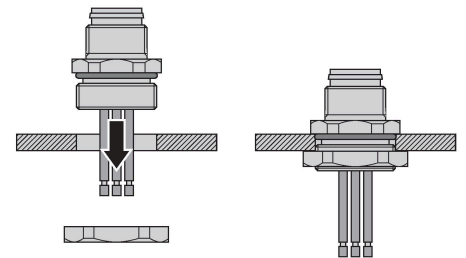

Accessories

**LOCKNUT-PG9-316SS-(10/BAG)**

**A9583**



Locknut, PG9, 316 Stainless Steel, 10 per bag

**FK(S)FD-TOOL**

**A2550**

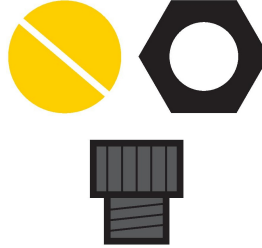

Tool, knockout hole punch, receptacle-mounting hole. Accommodates PG9 threads.

**DECAL,9-CLRS,RECEPT+BOXES,EURO(QTY1)**

**100008955**

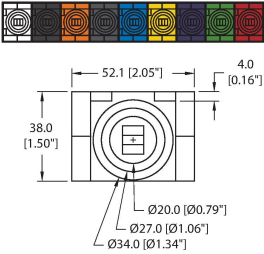

1 decal sticker containing 9 different color sets of 11 decals to color code a sensor, junction block port, cable end, or receptacle. 5ct 4x9mm rectangles, 4ct 8x19mm rectangles, 1ct 27mm ID ring, 1ct 20mm ID ring.

**ORING-Ø7x1.5-M12-(10/BAG)**

**100024937**

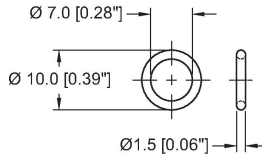

10 pack of Ø7x1.5 FKM O-rings for female M12 connectors

Accessories

**M12-GASKET-PG9,M16,1/4NPT-(10/BAG)**

**100015009**

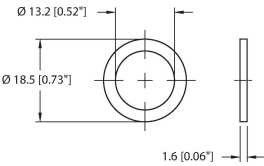

Gasket, Black NBR, Fits PG9, M16 and 1/4NPT mounting threads, 10 per bag