

ERSVG-A4.400.2-2

Actuator and Sensor Receptacle – Rear Mount

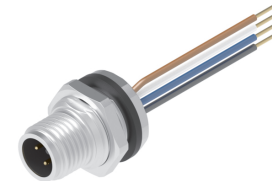
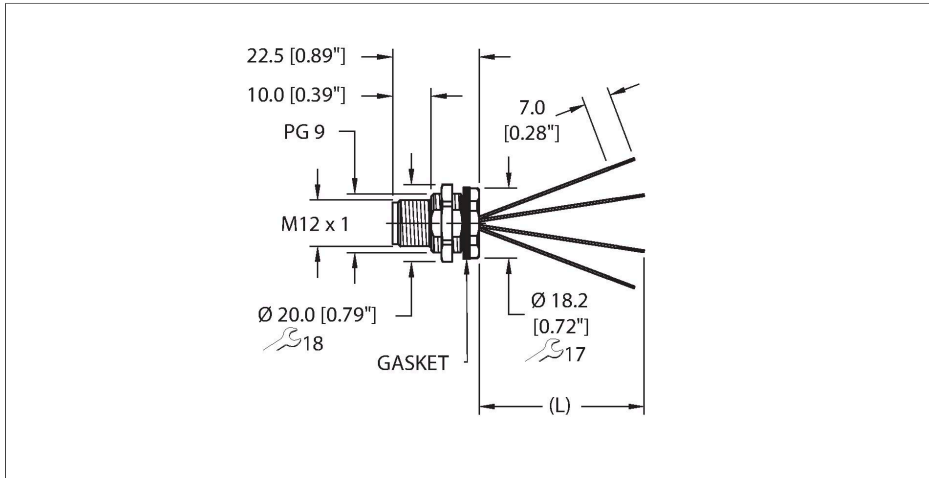

Technical data

Type	ERSVG-A4.400.2-2
ID	100027037
Replaces	FSFDV 4.4-x
Connector A	Male, M12 × 1, A-code
Design specification	Acc. to IEC 61076-2-101
Number of contacts	4
Contacts	Bronze, CuSn, Gold-plated
Contact carriers	Plastic, TPU, Black
Housing material/finish	Stainless Steel, Passivated
Tightening torque (range)	0.4 ... 1.8 Nm (note max. torque of mating connector!)
Mounting orientation	Rear mount
Panel seal	Gasket, NBR
Mounting thread	PG9
Locknut	Stainless Steel, Passivated
Receptacle mounting torque	2.5...6.8 Nm
Mechanical life	> 100 Mating cycles
Pollution degree	3
Protection class (When coupled)	IP67, IP68, IP69, IP69K NEMA: 1, 3, 4, 4X, 6P, 12
Conductor data	
Total number of conductors	4
Length (L)	2 m, 2 m, (+50mm or 4% of length/-0.0, Whichever is greater)

Features



- M12, Male, Receptacle, Rear mount, 4-pin
- Mounting thread: PG9

Contact assignment

Connector A

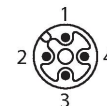

Circuit Diagram



Technical data

Conductor material	TC (tinned copper)
Conductor insulation material	PVC
Conductor size	22 AWG [Similar to 0.34 mm ²]
Conductor colors	BN, WH, BU, BK
Electrical properties at +20 °C	
Rated voltage	250 V _{AC} /300 V _{DC}
Current	4 A
Mechanical and chemical properties	
Ambient temperature range (static)	-40 °C...+105 °C
Approvals	UL 2238 CSA C22.2 No. 182.3 CE UKCA RoHS
Note	
- We reserve the right to make technical alterations without prior notice.	

Mounting hole - Through

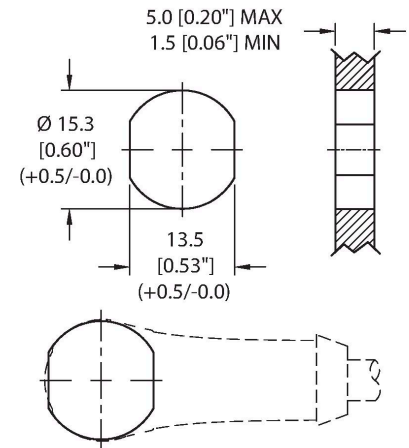

Mounting hole - Threaded

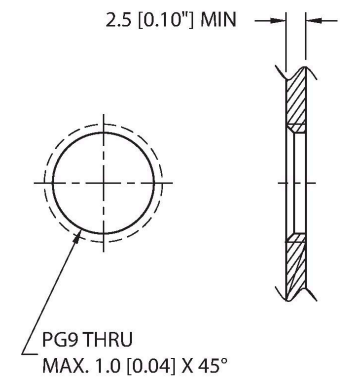

Rear-mounted

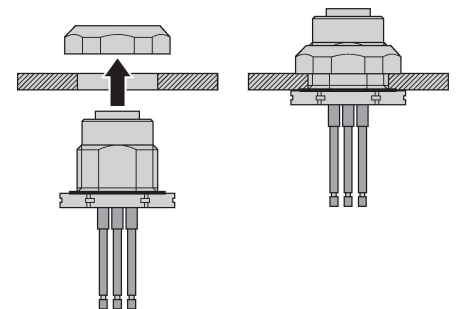

Accessories

FK(S)FD-TOOL

A2550



Tool, knockout hole punch, receptacle-mounting hole. Accommodates PG9 threads.

DECAL,9-CLRS,RECEPT+BOXES,EURO(QTY1)

100008955



1 decal sticker containing 9 different color sets of 11 decals to color code a sensor, junction block port, cable end, or receptacle. 5ct 4x9mm rectangles, 4ct 8x19mm rectangles, 1ct 27mm ID ring, 1ct 20mm ID ring.

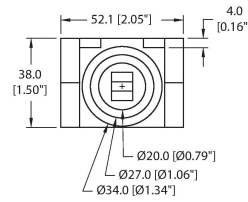

Accessories

LOCKNUT-PG9-316SS-(10/BAG)

A9583

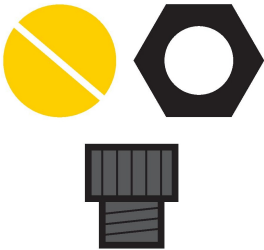

Locknut, PG9, 316 Stainless Steel, 10 per bag