

NI40-G47SR-FZ3X2

Inductive Sensor

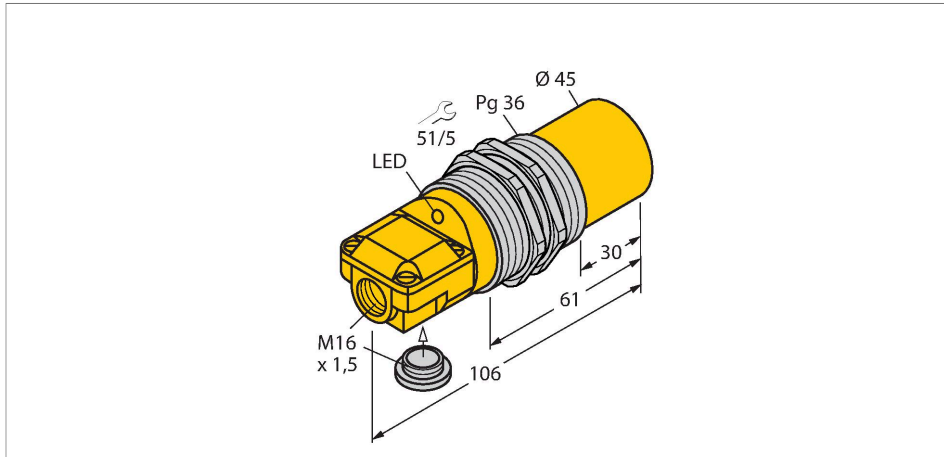

Features

- 2 cable entries (axial, radial)
- Threaded barrel, Pg36
- Chrome-plated brass
- AC 2-wire, 20...250 VAC
- DC 2-wire, 10...300 VDC
- NC/NO programmable
- Terminal chamber

Wiring diagram

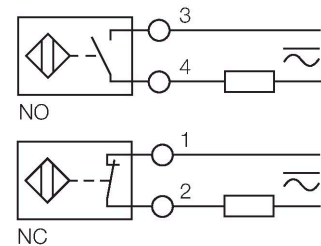

Technical data

Type	NI40-G47SR-FZ3X2
ID	13428
General data	
Rated switching distance	40 mm
Mounting conditions	Non-flush
Secured operating distance	$\leq (0.81 \times S_n)$ mm
Correction factors	St37 = 1; Al = 0.3; stainless steel = 0.7; Ms = 0.4
Repeat accuracy	≤ 2 % of full scale
Temperature drift	$\leq \pm 10$ %
Hysteresis	3...15 %
Electrical data	
Operating voltage	20...250 VAC
Operating voltage	10...300 VDC
AC rated operational current	≤ 400 mA
DC rated operational current	≤ 300 mA
Frequency	$\geq 50 \dots \leq 60$ Hz
Residual current	≤ 1.7 mA
Isolation test voltage	≤ 1.5 kV
Surge current	≤ 8 A (≤ 10 ms max. 5 Hz)
Voltage drop at I_e	≤ 6 V
Output function	2-wire, Connection programmable, 2-wire
Smallest operating current	≥ 3 mA
Switching frequency	0.02 kHz

Functional principle

Inductive sensors detect metal objects contactless and wear-free. For this, they use a high-frequency electromagnetic AC field that interacts with the target. Inductive sensors generate this field via an RLC circuit with a ferrite coil.

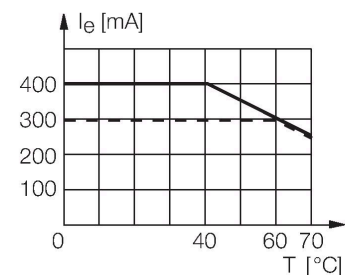

Technical data

Mechanical data	
Design	Threaded barrel, G47
Dimensions	106 mm
Housing material	Metal, CuZn, Chrome-plated
Active area material	Plastic, PA12-GF30
Max. tightening torque of housing nut	90 Nm
Electrical connection	Terminal chamber
Clamping ability	≤ 2.5 mm ²
Environmental conditions	
Ambient temperature	-25...+70 °C
Vibration resistance	55 Hz (1 mm)
Shock resistance	30 g (11 ms)
Protection class	IP67
MTTF	2283 years acc. to SN 29500 (Ed. 99) 40 °C
Power-on indication	LED, Green
Switching state	LED, Red
Included in delivery	cable gland, blanking plug

Mounting instructions

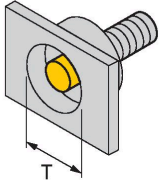
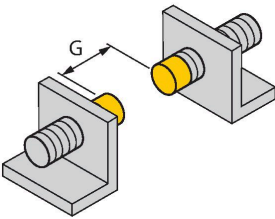
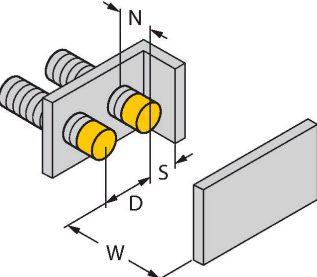
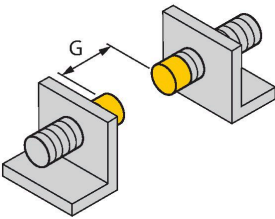
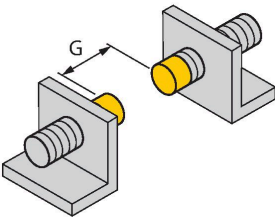
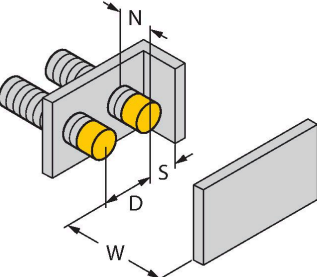
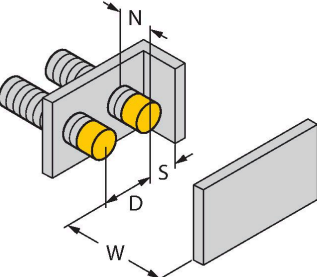
Mounting instructions/Description		
	Distance D	3 x B
		Distance W
	Distance T	3 x B
		Distance S
	Distance G	6 x Sn
		Distance N
	Diameter active area B	Ø 47 mm

Accessories

MW47

69452

Mounting bracket; material: Steel
plate, galvanized

