

BI8-M18-LI-EXI

Inductive Sensor – With Analog Output

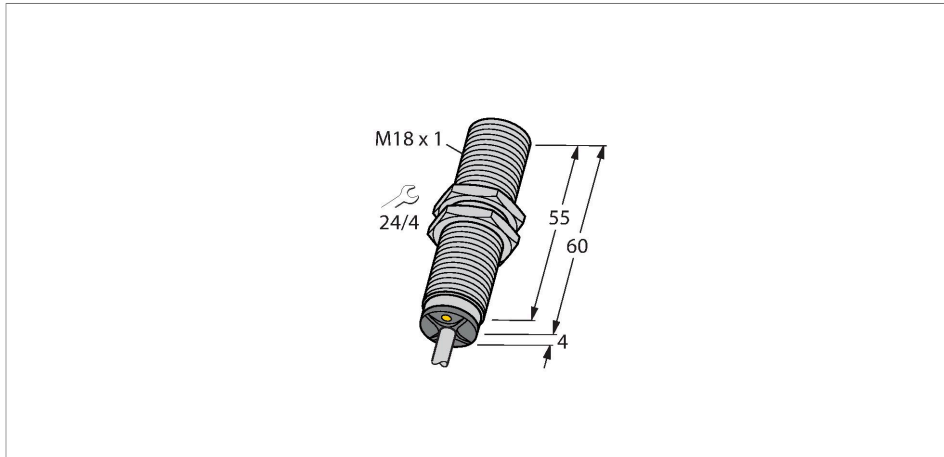

Features

- Threaded barrel, M18 x 1
- Chrome-plated brass
- 2-wire, 14...30 VDC
- Analog output
- 4...20 mA
- Cable connection
- ATEX category II 1 G, Ex-zone 0
- ATEX category II 2 D, Ex-zone 21

Wiring diagram

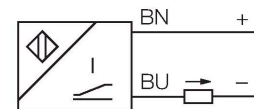

Technical data

Type	BI8-M18-LI-EXI
ID	1535528
General data	
Measuring range	1...5 mm
Mounting conditions	Flush
Secured operating distance	$\leq (0.81 \times S_n)$ mm
Correction factors	St37 = 1; Al = 0.3; stainless steel = 0.7; Ms = 0.4
Repeatability	≤ 1 % of measuring range A - B
	0.5 %, after warm-up 0.5 h
Linearity deviation	≤ 5 %
Temperature drift	$\leq \pm 0.06$ %/K
Electrical data	
Operating voltage	14...30 VDC
	at the electrical connection of the sensor
Residual ripple	≤ 10 % U_{ss}
Isolation test voltage	≤ 0.5 kV
Short-circuit protection	yes
Wire breakage/Reverse polarity protection	no / Complete
Output function	2-wire, Analog output
Current output	4...20 mA
Load resistance current output	$\leq [(U_b - 14 \text{ V}) / 20 \text{ mA}]$
Measuring sequence frequency	200 Hz
Approval acc. to	KEMA 03 ATEX 1122 X Output no. 5

Functional principle

Inductive TURCK sensors with analog output accomplish simple control tasks. They provide a current, voltage or frequency signal proportional to the target's distance. The output signal is linear to the distance of the target over the entire sensing range.

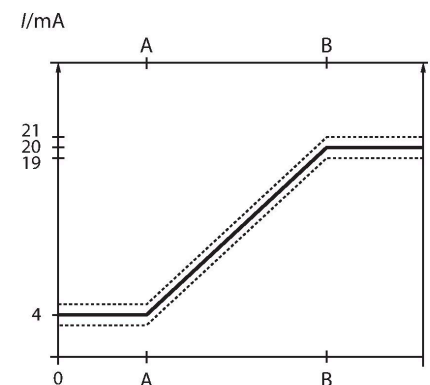

Technical data

Internal capacitance (C)/inductance (L)	240 nF/2 µH
Device marking	Ex II 1 G Ex ia IIC T6 Ga / II 2 D Ex ia IIIC T85°C Db (max. U _i = 30 V, I _i = 120 mA, P _i = 600mW)
Mechanical data	
Design	Threaded barrel, M18 x 1
Dimensions	64 mm
Housing material	Metal, CuZn, Chrome-plated
Active area material	Plastic, PA12-GF30
End cap	Plastic, EPTR
Max. tightening torque of housing nut	25 Nm
Electrical connection	Cable
Cable quality	Ø 5.2 mm, Blue, LifYY, PVC, 2 m
Core cross-section	2 x 0.34 mm ²
Environmental conditions	
Ambient temperature	-25...+70 °C For explosion hazardous areas see instruction leaflet
Vibration resistance	55 Hz (1 mm)
Shock resistance	30 g (11 ms)
Protection class	IP67
MTTF	751 years acc. to SN 29500 (Ed. 99) 40 °C

Mounting instructions

Mounting instructions/Description



Distance D	2 x B
Distance W	12 mm
Distance T	3 x B
Distance S	1.5 x B
Distance G	24 mm
Diameter active area B	Ø 18 mm

Accessories

BST-18B

6947214

Mounting clamp for threaded barrel sensors, with dead-stop; material: PA6

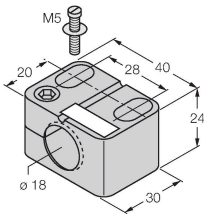

QM-18

6945102

Quick-mount bracket with dead-stop; material: Chrome-plated brass. Male thread M24 x 1.5. Note: The switching distance of the proximity switches may change when using quick-mount brackets.

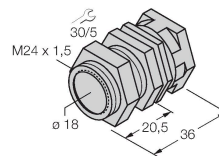

MW-18

6945004

Mounting bracket for threaded barrel sensors; material: Stainless steel A2 1.4301 (AISI 304)



BSS-18

6901320

Mounting clamp for smooth and threaded barrel sensors; material: Polypropylene

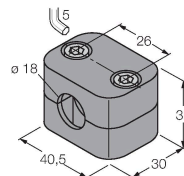

IM33-11EX-HI

7506443

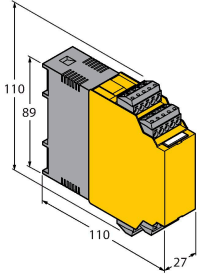

Isolating transducers; 1-channel; power supply of 2-wire measuring transducers with HART communication as well as connection of active 2-wire and passive 3-wire transmitters

Instructions for use

Intended use

This device fulfills the directive 2014/34/EC and is suited for use in explosion hazardous areas according to EN 60079-0:2018 + A11 and EN 60079-11:2012. In order to ensure correct operation to the intended purpose it is required to observe the national regulations and directives.

For use in explosion hazardous areas conform to classification

II 1 G and II 2 D (Group II, Category 1 G, electrical equipment for gas-atmospheres and category 2 D, electrical equipment for dust atmospheres)

Marking (see device or technical data sheet)

⊕ II 1 G Ex ia IIC T6 Ga und ⊕ II 2 D Ex ia IIIC T85°C Db acc. to EN 60079-0, -11

Local admissible ambient temperature

-25...+65 °C

Installation/Commissioning

These devices may only be installed, connected and operated by trained and qualified staff. Qualified staff must have knowledge of protection classes, directives and regulations concerning electrical equipment designed for use in explosion hazardous areas. Please verify that the classification and the marking on the device comply with the actual application conditions.

This device is only suited for connection to approved Exi circuits according to EN 60079-0 and EN 60079-11. Please observe the maximum admissible electrical values. After connection to other circuits the sensor may no longer be used in Exi installations. When interconnected to (associated) electrical equipment, it is required to perform the "Proof of intrinsic safety" (EN60079-14).

Installation and mounting instructions

Avoid static charging of cables and plastic devices. Please only clean the device with a damp cloth. Do not install the device in a dust flow and avoid build-up of dust deposits on the device. If the devices and the cable could be subject to mechanical damage, they must be protected accordingly. They must also be shielded against strong electro-magnetic fields. The pin configuration and the electrical specifications can be taken from the device marking or the technical data sheet. In order to avoid contamination of the device, please remove possible blanking plugs of the cable glands or connectors only shortly before inserting the cable or opening the cable socket.

Service/Maintenance

Repairs are not possible. The approval expires if the device is repaired or modified by a person other than the manufacturer. The most important data from the approval are listed.