

BI5-M18-LIU

Inductive Sensor – With Analog Output

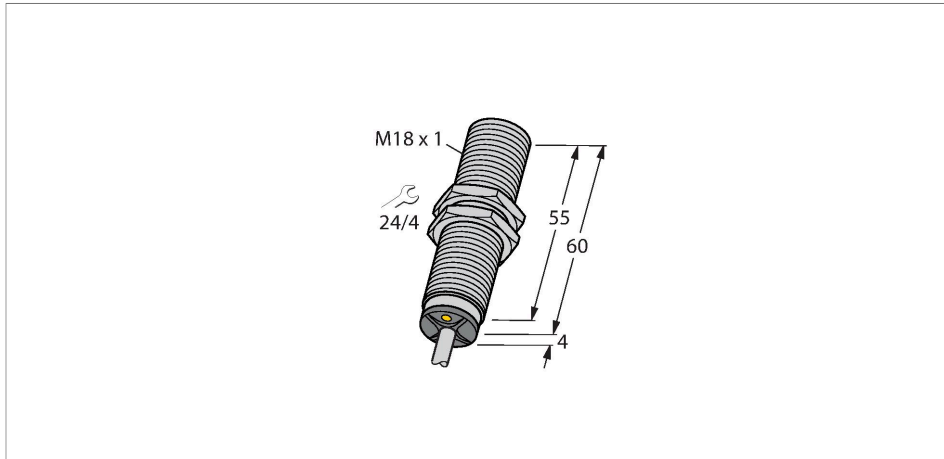

Features

- Threaded barrel, M18 x 1
- Chrome-plated brass
- 4-wire, 15...30 VDC
- Analog output
- 0...10 V and 0...20 mA
- Cable connection

Wiring diagram

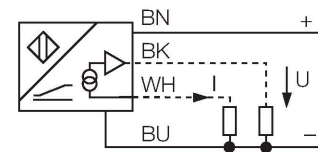

Technical data

Type	BI5-M18-LIU
ID	1536000
General data	
Measuring range	2...4 mm
Mounting conditions	Flush
Secured operating distance	$\leq (0.81 \times S_n)$ mm
Correction factors	St37 = 1; Al = 0.3; stainless steel = 0.7; Ms = 0.4
Repeatability	$\leq 1\%$ of measuring range A - B
	0.5 %, after warm-up 0.5 h
Reproducibility	$\leq 20\ \mu\text{m}$
	$\leq 10\ \mu\text{m}$, after a warm-up time of 0.5 h
Linearity deviation	$\leq 3\%$
Temperature drift	$\leq \pm 0.06\ \%/K$
Electrical data	
Operating voltage	15...30 VDC
Residual ripple	$\leq 10\% U_{ss}$
No-load current	8 mA
Isolation test voltage	$\leq 0.5\ \text{kV}$
Short-circuit protection	yes
Wire breakage/Reverse polarity protection	no / Complete
Output function	4-wire, Analog output
Voltage output	0...10 V
Current output	0...20 mA

Functional principle

Inductive TURCK sensors with analog output accomplish simple control tasks. They provide a current, voltage or frequency signal proportional to the target's distance. The output signal is linear to the distance of the target over the entire sensing range.

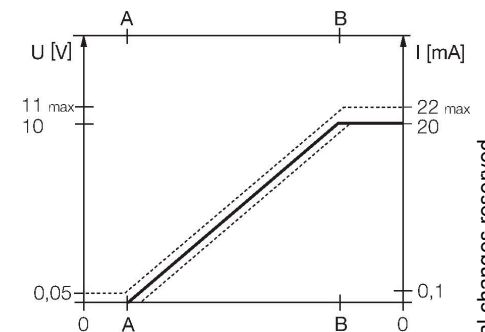

Technical data

Load resistance voltage output	$\geq 4.7 \text{ k}\Omega$
Load resistance current output	$\leq 0.4 \text{ k}\Omega$
Measuring sequence frequency	200 Hz
Mechanical data	
Design	Threaded barrel, M18 x 1
Dimensions	64 mm
Housing material	Metal, CuZn, Chrome-plated
Active area material	Plastic, PA12-GF30
End cap	Plastic, EPTR
Max. tightening torque of housing nut	25 Nm
Electrical connection	Cable
Cable quality	$\varnothing 5.2 \text{ mm}$, Gray, LifYY, PVC, 2 m
Core cross-section	$4 \times 0.34 \text{ mm}^2$
Environmental conditions	
Ambient temperature	-25...+70 °C
Vibration resistance	55 Hz (1 mm)
Shock resistance	30 g (11 ms)
Protection class	IP67
MTTF	751 years acc. to SN 29500 (Ed. 99) 40 °C

Mounting instructions

Mounting instructions/Description



Distance D	2 x B
Distance W	12 mm
Distance T	3 x B
Distance S	1.5 x B
Distance G	24 mm
Diameter active area B	Ø 18 mm

Accessories

BST-18B

6947214

Mounting clamp for threaded barrel sensors, with dead-stop; material: PA6

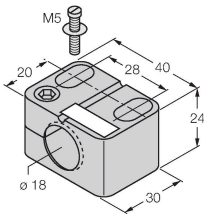

QM-18

6945102

Quick-mount bracket with dead-stop; material: Chrome-plated brass. Male thread M24 x 1.5. Note: The switching distance of the proximity switches may change when using quick-mount brackets.

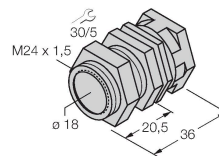

MW-18

6945004

Mounting bracket for threaded barrel sensors; material: Stainless steel A2 1.4301 (AISI 304)



BSS-18

6901320

Mounting clamp for smooth and threaded barrel sensors; material: Polypropylene

