

BI5-M18E-LIU-H1141

Inductive Sensor – With Analog Output

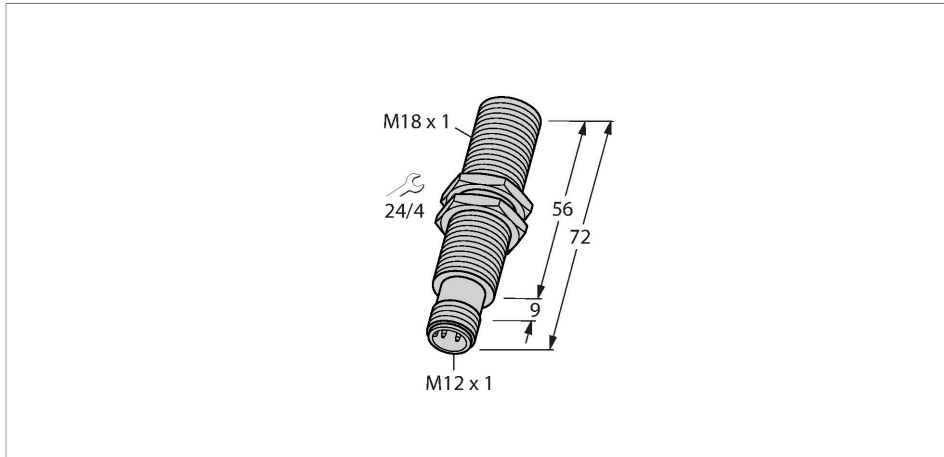

Features

- Threaded barrel, M18 x 1
- Chrome-plated brass
- 4-wire, 15...30 VDC
- Analog output
- 0...10 V and 0...20 mA
- M12 x 1 male connector

Wiring diagram

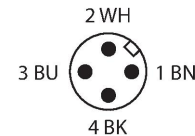
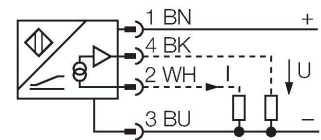

Technical data

Type	BI5-M18E-LIU-H1141
ID	1536205
General data	
Measuring range	2...4 mm
Mounting conditions	Flush
Secured operating distance	$\leq (0.81 \times S_n)$ mm
Correction factors	St37 = 1; Al = 0.3; stainless steel = 0.7; Ms = 0.4
Repeatability	$\leq 1 \%$ of measuring range A - B
	0.5 %, after warm-up 0.5 h
Reproducibility	$\leq 20 \mu\text{m}$
	$\leq 10 \mu\text{m}$, after a warm-up time of 0.5 h
Linearity deviation	$\leq 3 \%$
Temperature drift	$\leq \pm 0.06 \%$ /K
Electrical data	
Operating voltage	15...30 VDC
Residual ripple	$\leq 10 \%$ U_{ss}
No-load current	8 mA
Isolation test voltage	≤ 0.5 kV
Short-circuit protection	yes
Wire breakage/Reverse polarity protection	no / Complete
Output function	4-wire, Analog output
Voltage output	0...10 V
Current output	0...20 mA

Functional principle

Inductive TURCK sensors with analog output accomplish simple control tasks. They provide a current, voltage or frequency signal proportional to the target's distance. The output signal is linear to the distance of the target over the entire sensing range.

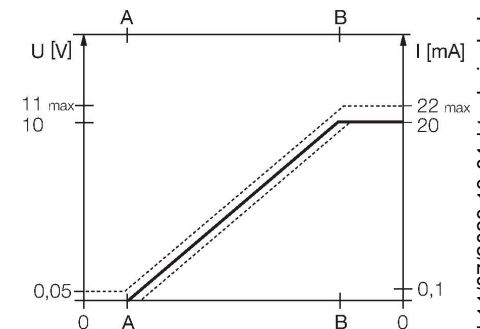

BI5-M18E-LIU-H1141 | 11/07/2023 13-04 | technical changes reserved

Technical data

Load resistance voltage output	$\geq 4.7 \text{ k}\Omega$
Load resistance current output	$\leq 0.4 \text{ k}\Omega$
Measuring sequence frequency	200 Hz
Mechanical data	
Design	Threaded barrel, M18 x 1
Dimensions	72 mm
Housing material	Metal, CuZn, Chrome-plated
Active area material	Plastic, PA12-GF30
Max. tightening torque of housing nut	25 Nm
Electrical connection	Connector, M12 x 1
Environmental conditions	
Ambient temperature	-25...+70 °C
Vibration resistance	55 Hz (1 mm)
Shock resistance	30 g (11 ms)
Protection class	IP67
MTTF	751 years acc. to SN 29500 (Ed. 99) 40 °C

Mounting instructions

Mounting instructions/Description



Distance D	2 x B
Distance W	12 mm
Distance T	3 x B
Distance S	1.5 x B
Distance G	24 mm
Diameter active area B	Ø 18 mm

Accessories

QM-18

6945102

Quick-mount bracket with dead-stop; material: Chrome-plated brass. Male thread M24 × 1.5. Note: The switching distance of the proximity switches may change when using quick-mount brackets.

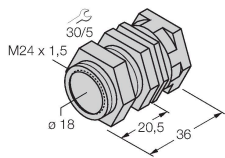

BST-18B

6947214

Mounting clamp for threaded barrel sensors, with dead-stop; material: PA6

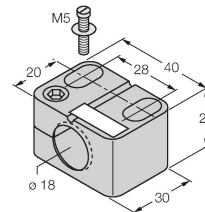

MW-18

6945004

Mounting bracket for threaded barrel sensors; material: Stainless steel A2 1.4301 (AISI 304)



BSS-18

6901320

Mounting clamp for smooth and threaded barrel sensors; material: Polypropylene

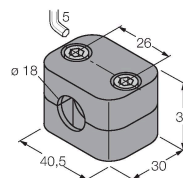

Wiring accessories

Dimension drawing	Type	ID	
	RKC4.4T-2/TEL	6625013	Connection cable, M12 female connector, straight, 4-pin, cable length: 2 m, jacket material: PVC, black; cULus approval
	RKC4.301T-0.15-RSC4.334T/TXL	6631382	Extension cable, M12 female/male, straight, 4-pin, cable length: 0.15m, jacket material: PUR, black; cULus approval; Adapter cable for sensors with analog output on pin 2, for connection to analog inputs of fieldbus modules with 4-wire technology