

EKRL-EKWL-A4.400-DC82-50

Actuator and Sensor Cordset – Extension Cable

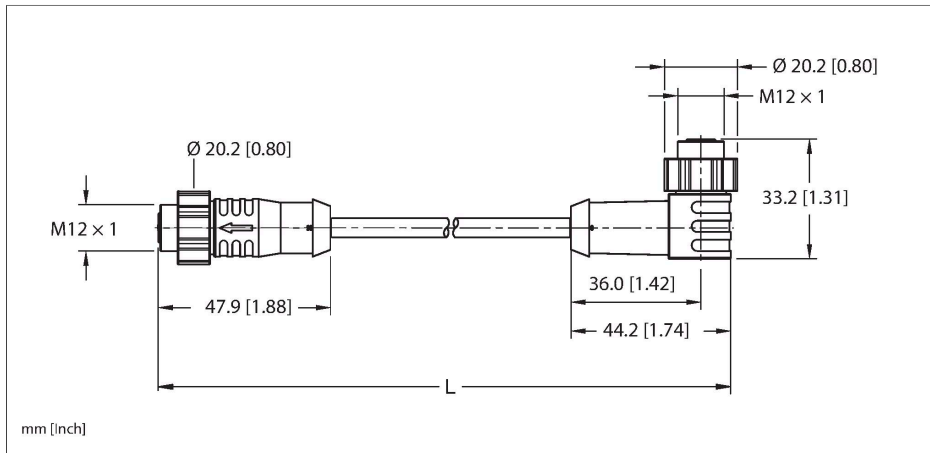

Features

-
- M12, Female, Straight, 4-pin, Torque sleeve
- M12, Female, Right angle, 4-pin, Torque sleeve
- Instrumentation Tray/Exposed Run/Direct Burial Cable
- Blue PVC jacket, shielded, 4X18 AWG
- Sunlight Resistant
- -40 Cold Bend Rating
- Oil Resistant
- Flame Ratings: UL 1685 FT4, UL1061, CSA FT4

Cable cross section

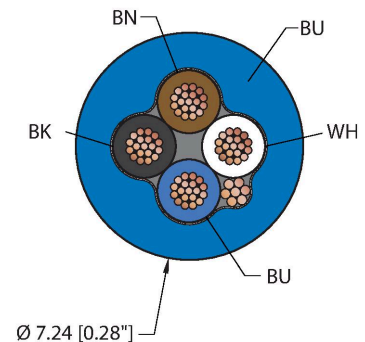

Contact assignment

Connector A

Connector B

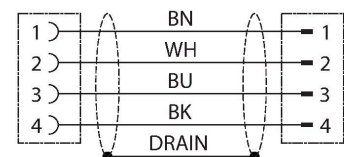
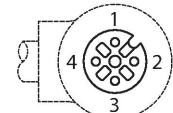
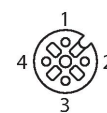

Technical data

Type	EKRL-EKWL-A4.400-DC82-50
ID	200000973
Replaces	RKCV 4.4T-x/-WKCV/S618
Connector A	Female, M12 × 1, Straight, A-code
Design specification	Acc. to IEC 61076-2-101
Number of contacts	4
Contacts	Bronze, CuSn, Gold-plated
Contact carriers	Plastic, Nylon or TPU, Black
Connector body	Plastic, TPU, Black
Coupling nut	Stainless Steel, 316L (1.4404), Passivated
Connector seal	O-ring, Plastic, FKM/FPM
Torque sleeve	Plastic, PA, Yellow
Tightening torque (range)	0.4 ... 1.8 Nm (note max. torque of mating connector!)
Mechanical life	> 100 Mating cycles
Pollution degree	3
Protection class (When coupled)	IP67, IP68, IP69, IP69K NEMA: 1, 3, 4, 4X, 6P, 12
Connector B	Female, M12 × 1, Right angle, A-code
Design specification	Acc. to IEC 61076-2-101
Number of contacts	4
Contacts	Bronze, CuSn, Gold-plated
Contact carriers	Plastic, Nylon or TPU, Black
Connector body	Plastic, TPU, Black

Technical data

Coupling nut	Stainless Steel, 316L (1.4404), Passivated
Seal	O-ring, Plastic, FKM/FPM
Torque sleeve	Plastic, PA, Yellow
Tightening torque	0.4 ... 1.8 Nm (note max. torque of mating connector!)
Mechanical life	> 100 Mating cycles
Pollution degree	3
Protection class (When coupled)	IP67, IP68, IP69, IP69K NEMA: 1, 3, 4, 4X, 6P, 12
Cable data	
Cable ID	RF51727
Total number of conductors	4
Cable diameter	Ø 7.24 mm
Length (L)	50 m, (+50mm or 4% of length/-0.0, Whichever is greater)
Cable jacket	PVC, Blue
Shield	Aluminum/polyester (IN)
Cable drain	20 AWG, TC (Tinned Copper)
Conductor diameter	0.077 "
Conductor material	TC (tinned copper)
Conductor insulation material	PVC/Nylon (Nylon overcoat)
Conductor size	4 x 18 AWG [Similar to 0.75 mm ²]
Number of strands x O.D.	19 x 0.0092 "
Conductor colors	BN, WH, BU, BK
Electrical properties at +20 °C	
Rated voltage	250 V _{AC} /300 V _{DC}
Current	5 A
Mechanical and chemical properties	
Bending radius (static)	≥ 5 x Ø
Bending radius (dynamic)	≥ 15 x Ø
UL cold bend rating	-40 °C
Ambient temperature range (static)	-40...+105 °C
Ambient temperature range (dynamic)	5...+105 °C
Temperature range (installation)	-10...+105 °C
Approval	
Approvals	UL 2238 CSA C22.2 No. 182.3 CE UKCA

Technical data

RoHS

Note

- Flex ratings may be reduced if used in extreme temperatures, exposure to certain chemicals, operating above the rated cycle speed, or operating below the rated cable bend radius.

- The torque sleeve can be removed, before or after installation by inserting a small flat screwdriver near the relief by the arrow and prying.

- We reserve the right to make technical alterations without prior notice.

Accessories

M12-TORQUE-SLEEVE,YELLOW(10PACK)

A900167



10 Pack of Yellow Torque Sleeves for the new M12 cordsets. Compatible with male, female, straight and right-angled, stainless steel and nickel-plated brass coupling nuts.

TORQUE-WRENCH-SET-M12/SW13

A900152

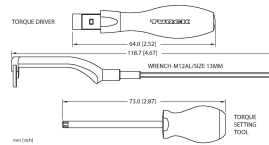

Adjustable torque driver to connect to the 13mm hex. Compatible with redesigned M12 cordsets, M12 Power, and M12 X-code. NOT Compatible with legacy M12 cordsets. Includes (1) adjustable torque driver, (1) adjustment tool, and (1) 13mm forked bit.

Accessories

M12-CORDSETS-MOUNTING-CLIP-(10/BAG)

100016882

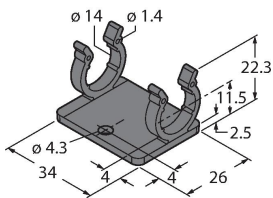

10 Pack of black mounting clips and M4x8mm mounting screws, used to secure cable to cable connection points.