

EFSVT-A5.500.2-0.2

Actuator and Sensor Receptacle – Front Mount

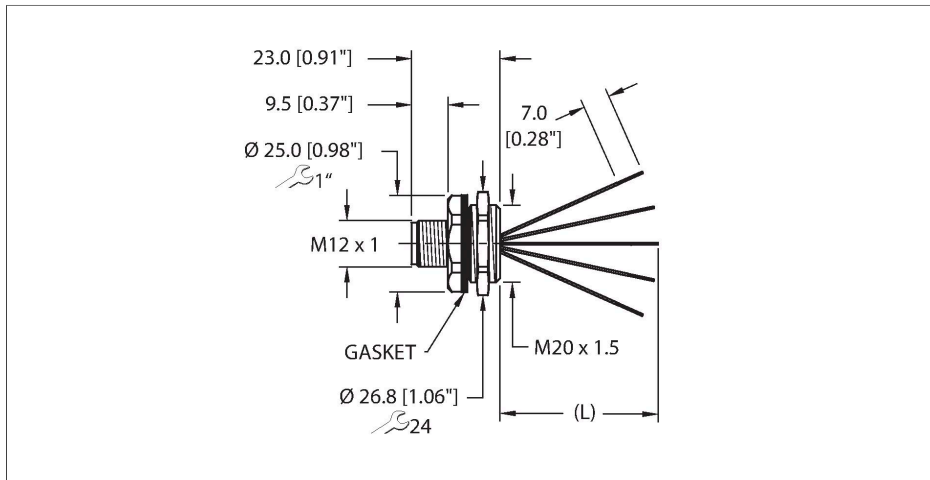

Features



- M12, Male, Receptacle, Front mount, 5-pin
- Mounting thread: M20 × 1.5

Contact assignment

Connector A

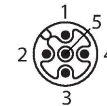

Circuit Diagram

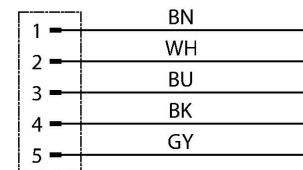

Mounting hole - Through

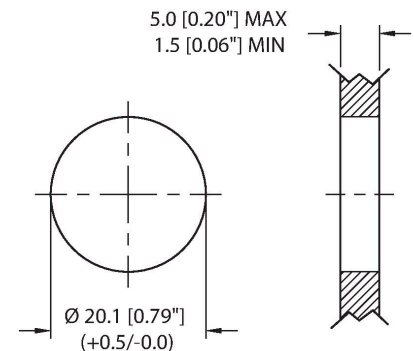

Technical data

Type	EFSVT-A5.500.2-0.2
ID	200002273
Replaces	FSV 4.5-x/M20
Connector A	Male, M12 × 1, A-code
Design specification	Acc. to IEC 61076-2-101
Number of contacts	5
Contacts	Bronze, CuSn, Gold-plated
Contact carriers	Plastic, TPU, Black
Housing material/finish	Stainless Steel, Passivated
Tightening torque (range)	0.4 ... 1.8 Nm (note max. torque of mating connector!)
Mounting orientation	Front mount
Panel seal	Gasket, NBR
Mounting thread	M20 × 1.5
Locknut	Stainless Steel, Passivated
Receptacle mounting torque	3.5...9.6 Nm
Mechanical life	> 100 Mating cycles
Pollution degree	3
Protection class (When coupled)	IP67, IP68, IP69, IP69K NEMA: 1, 3, 4, 4X, 6P, 12
Conductor data	
Total number of conductors	5
Length (L)	0.2 m, (+50mm or 4% of length/-0.0, Whichever is greater)

Technical data

Conductor material	TC (tinned copper)
Conductor insulation material	PVC
Conductor size	22 AWG [Similar to 0.34 mm ²]
Conductor colors	BN, WH, BU, BK, GY
Electrical properties at +20 °C	
Rated voltage	250 V _{AC} /300 V _{DC}
Current	4 A
Mechanical and chemical properties	
Ambient temperature range (static)	-40 °C...+105 °C
Approvals	UL 2238 CSA C22.2 No. 182.3 CE UKCA RoHS

Note

- We reserve the right to make technical alterations without prior notice.

Mounting hole - Threaded

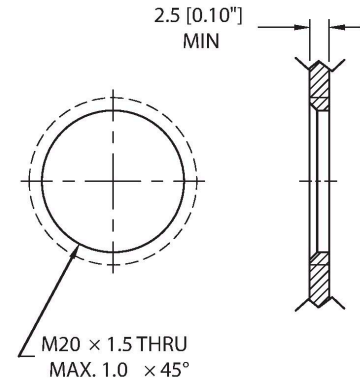

Front panel mounting

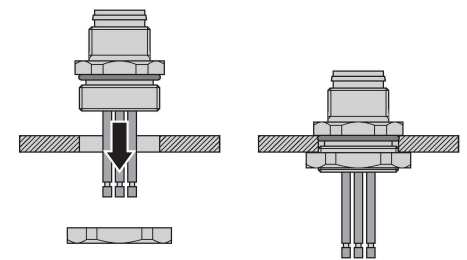

Accessories

DECAL,9-CLRS,RECEPT+BOXES,EURO(QTY1) 100008955

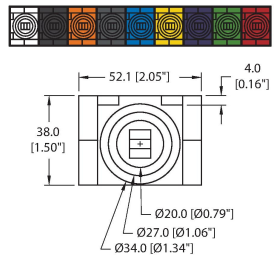

1 decal sticker containing 9 different color sets of 11 decals to color code a sensor, junction block port, cable end, or receptacle. 5ct 4x9mm rectangles, 4ct 8x19mm rectangles, 1ct 27mm ID ring, 1ct 20mm ID ring.

Accessories

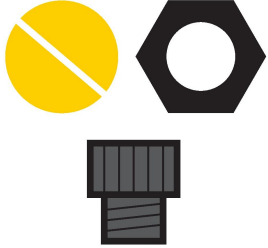
LOCKNUT-M20-316SS-(10/BAG)**A9194**

Locknut, M20, 316 Stainless Steel, 10 per bag

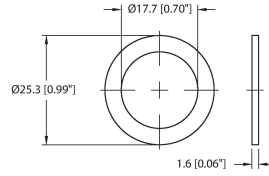
M12-GASKET-M20,1/2NPT-(10/BAG)**100024930**

Gasket, Black NBR, Fits M20 and 1/4NPT mounting threads, 10 per bag