

BI1-EH04-AN6X-0.3-RS4T

Inductive Sensor

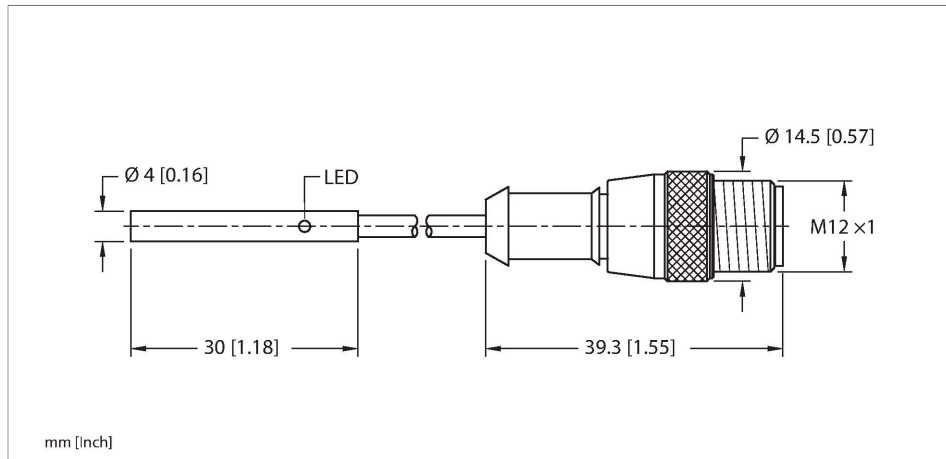

Features

- Smooth barrel, Ø 4 mm
- Stainless steel 1.4305 (AISI 303)
- DC 3-wire, 10...30 VDC
- NO contact, NPN output
- Pigtail with M12 × 1 connector

Wiring diagram



Technical data

Type	BI1-EH04-AN6X-0.3-RS4T
ID	4609699
General data	
Rated switching distance	1 mm
Mounting conditions	Flush
Secured operating distance	≤ (0.81 × S _n) mm
Correction factors	St37 = 1; Al = 0.3; stainless steel = 0.7; Ms = 0.4
Repeat accuracy	≤ 2 % of full scale
Hysteresis	10 %
Electrical data	
Operating voltage	10...30 VDC
Residual ripple	≤ 10 % U _{ss}
DC rated operational current	≤ 100 mA
No-load current	15 mA
Residual current	≤ 0.1 mA
Isolation test voltage	≤ 0.5 kV
Short-circuit protection	yes / Cyclic
Voltage drop at I _o	≤ 1.8 V
Wire breakage/Reverse polarity protection	yes / Complete
Output function	3-wire, NO contact, NPN
Switching frequency	3 kHz
Mechanical data	
Design	Smooth barrel, 4 mm

Functional principle

Inductive sensors detect metal objects contactless and wear-free. For this, they use a high-frequency electromagnetic AC field that interacts with the target. Inductive sensors generate this field via an RLC circuit with a ferrite coil.

Technical data

Dimensions	30 mm
Housing material	Stainless steel, 1.4305 (AISI 303)
Active area material	Plastic, PA6.6
Electrical connection	Cable with connector, M12 × 1
Cable quality	Ø 3.3 mm, Gray, LifY-11Y, PUR, 0.3 m
Core cross-section	3 x 0.14 mm ²
Environmental conditions	
Ambient temperature	-25...+70 °C
Vibration resistance	55 Hz (1 mm)
Shock resistance	30 g (11 ms)
Protection class	IP67
MTTF	2283 years acc. to SN 29500 (Ed. 99) 40 °C
Switching state	LED, Yellow

Mounting instructions

Mounting instructions/Description

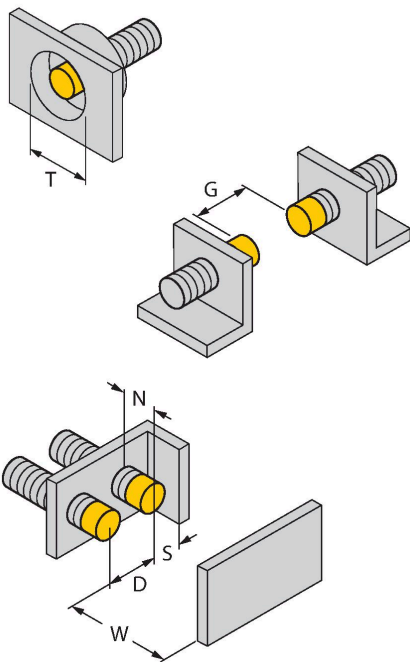

Distance D	2 × B
Distance W	3 × Sn
Distance T	3 × B
Distance S	1.5 × B
Distance G	6 × Sn
Diameter active area B	Ø 4 mm

Accessories

MBS40**69477**

Fixing clamp; material mounting
block: Anodized aluminium

