

EKWT-A4.300-GC2Y-x

Actuator and Sensor Cordset – Connection Cable

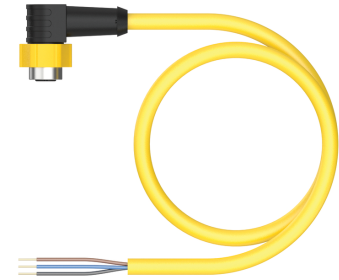
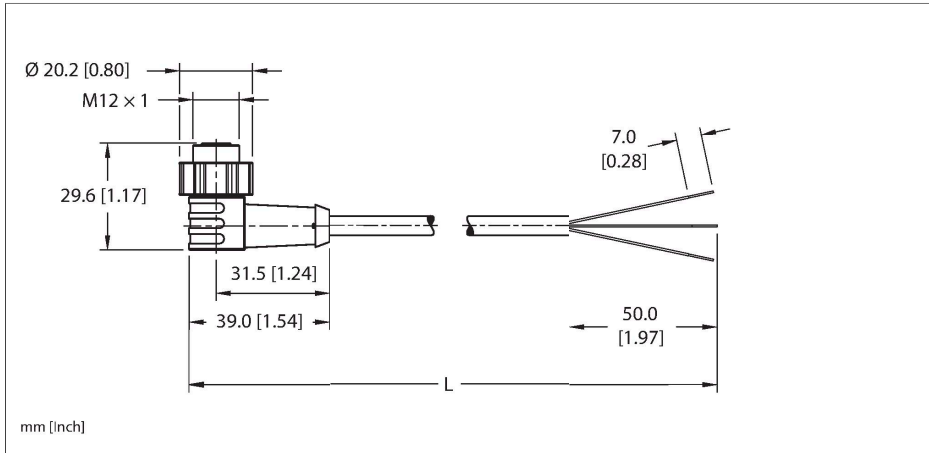

Technical data

Type	EKWT-A4.300-GC2Y-x
ID	777046395
Replaces	WK 4T-x/S715
Connector A	Female, M12 x 1, Right angle, A-code
Design specification	Acc. to IEC 61076-2-101
Number of contacts	4
Contacts	Bronze, CuSn, Gold-plated
Contact carriers	Plastic, Nylon or TPU, Black
Connector body	Plastic, TPU, Black
Coupling nut	Brass, CuZn, Nickel-plated
Connector seal	O-ring, Plastic, FKM/FPM
Torque sleeve	Plastic, PA, Yellow
Tightening torque (range)	0.4 ... 1.8 Nm (note max. torque of mating connector!)
Mechanical life	> 100 Mating cycles
Pollution degree	3
Protection class (When coupled)	IP67, IP68, IP69, IP69K NEMA: 1, 3, 4, 6P, 12
Cable data	
Cable ID	RF52087
Total number of conductors	3
Cable diameter	Ø 5.13 mm
Cable jacket	PVC, Yellow
Conductor diameter	0.054 "
Conductor material	TC (tinned copper)

Features

-
- M12, Female, Right angle, 3-pin, Torque sleeve
- Instrumentation Tray Cable
- Yellow PVC jacket, 3X22 AWG
- Sunlight Resistant
- -40 Cold Bend Rating
- Oil Resistant
- Flame Ratings: UL 1685 FT4, UL1061, CSA FT4

Cable cross section

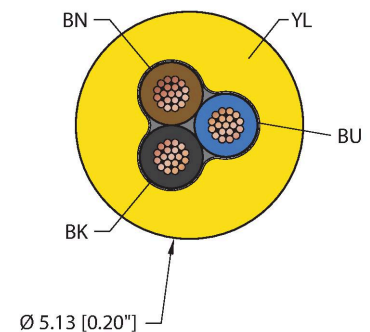

Contact assignment

Technical data

Conductor insulation material	PVC
Conductor size	3 x 22 AWG [Similar to 0.34 mm ²]
Number of strands x O.D.	19 x 0.0058 "
Conductor colors	BN, BU, BK
Electrical properties at +20 °C	
Rated voltage	250 V _{AC} /300 V _{DC}
Current	4 A
Mechanical and chemical properties	
Bending radius (static)	≥ 5 x Ø
Bending radius (dynamic)	≥ 10 x Ø
UL cold bend rating	-40 °C
Ambient temperature range (static)	-40 °C...+105 °C
Ambient temperature range (dynamic)	5 °C...+105 °C
Temperature range (installation)	-10 °C...+105 °C
Approval	
Approvals	UL 2238 CSA C22.2 No. 182.3 CE UKCA RoHS

Note	
	- Flex ratings may be reduced if used in extreme temperatures, exposure to certain chemicals, operating above the rated cycle speed, or operating below the rated cable bend radius.
	- The torque sleeve can be removed, before or after installation by inserting a small flat screwdriver near the relief by the arrow and prying.
	- We reserve the right to make technical alterations without prior notice.

Accessories

M12-TORQUE-SLEEVE, YELLOW(10PACK)	A900167
	10 Pack of Yellow Torque Sleeves for the new M12 cordsets. Compatible with male, female, straight and right-angled, stainless steel and nickel-plated brass coupling nuts.

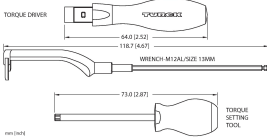
TORQUE-WRENCH-SET-M12/SW13	A900152
	Adjustable torque driver to connect to the 13mm hex. Compatible with redesigned M12 cordsets, M12 Power, and M12 X-code. NOT Compatible with legacy M12 cordsets. Includes (1) adjustable torque driver, (1) adjustment tool, and (1) 13mm forked bit.

Connector A

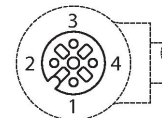

Circuit Diagram

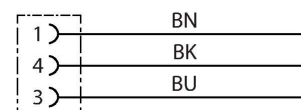

Accessories

M12-CORDSETS-MOUNTING-CLIP-(10/BAG)**100016882**

10 Pack of black mounting clips and M4x8mm mounting screws, used to secure cable to cable connection points.